

miniland humitouch

Adición de agua · Water adding · Adição de água
Ajout d'eau · Zugabe von wasser · Aggiunta di acqua
Dodawanie wody · Добавление воды

A

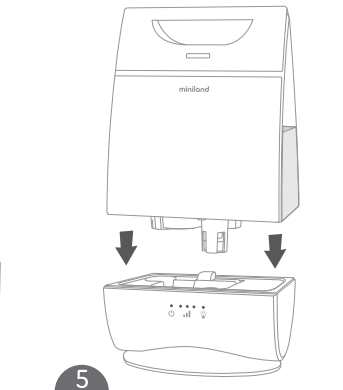
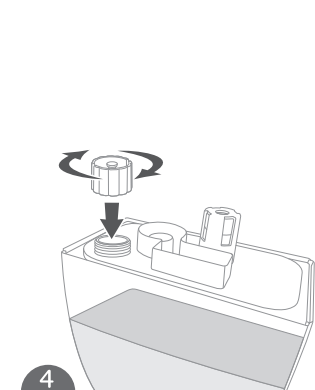
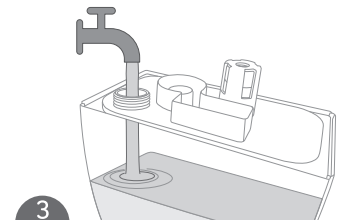
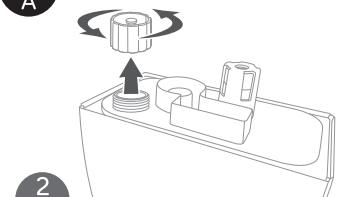
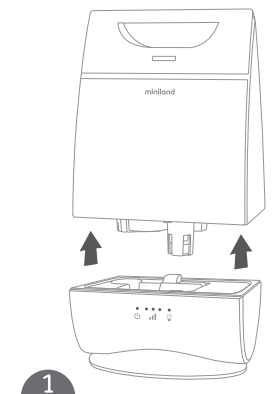

Encendido de la unidad · Turning the units on · Ligar as unidades
Allumage des unités · Einschalten des geräts · Accensione dell'unità
Włączanie urządzeń · Включение устройств

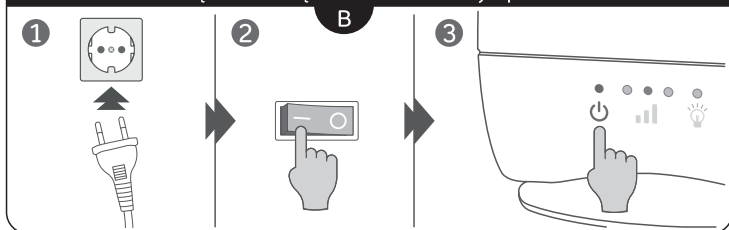

Ajuste de emisión de vapor · Adjustment of vapour release
Ajuste da emissão de vapor · Réglage des émissions de vapeur
Einstellung des dampfstomes · Regolazione di emissione di vapore
Regulacja emisji pary · Регулировка выхода пара

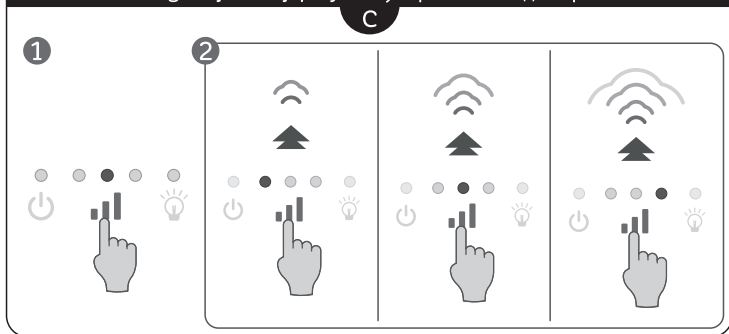

Luz nocturna · Nightlight · Luz noturna · Lumière nocturne · Nachtlichtlein
Luce notturna · Лампка носна · Ночной свет

